

A Better Approach to Passive Microphone Splitting

Jim Brown¹ and Bill Whitlock²

¹Audio Systems Group, Inc. Chicago, IL, 60640 USA
jim@audiosystemsgroup.com

²Jensen Transformers, Inc. Chatsworth, CA 91311 USA
whitlock@jensen-transformers.com

This paper was presented at the 118th AES Convention in Barcelona, May 2005. You can search the complete AES Electronic Library at <http://www.aes.org/e-lib/> This paper is available as Preprint 6338

ABSTRACT

While there are clear technical advantages to active microphone splitting, operational considerations dictate the use of passive splitting of microphones in most sound reinforcement applications. Modern microphones generally require a load impedance greater than 1,000 ohms, and performance often degrades significantly with heavier loading. Since mix desk input impedances rarely exceed 1,500 ohms, passive splitting utilizing 1:1 turns ratio transformers can seriously degrade microphone performance when driving two or more mix desks. Transformers designed to operate in stepdown mode solve this problem and offer other benefits. This paper reviews current practice, studies stepdown-mode splitting, and recommends that mixing desks be designed with higher input impedances and that microphones be designed to work with lower impedance loads.

INTRODUCTION

In live sound reinforcement, microphones often must feed two or three mix desks. One desk, located within the audience, mixes sound for the audience. A second desk on stage generates a foldback (stage monitor) mix for performers, while a third may be set up to produce a recording or broadcast mix. In many churches and multipurpose facilities, selected microphones will also feed an automatic mixer for use with simple programs.

A microphone feeding three mix desks will see the parallel combination of their individual input impedances, as well as the parallel combination of the capacitance of all of the interconnecting wiring. While input impedances on the order of 3,000 ohms could readily be achieved with thoughtful design, most modern mix desks have input impedances on the order of 1,250 ohms, and lower impedances are not unusual.

The output stage of a modern condenser microphone requires a careful compromise between the current available from the phantom power supply, the headroom needed, and the minimum load impedance. Many users, especially broadcasters and a few large scale touring sound companies, have chosen to solve the problem with an active splitter, whereby the microphone is preamplified and fed using a distribution amplifier or splitting transformer to multiple outputs. Active splitting is quite effective when it can be used, but operational considerations often dictate that it cannot.

Active splitting is problematic for three fundamental reasons. First, the dynamic range of live performance

often exceeds the dynamic range of input equipment, including the preamplifier used by the splitting system, by 30 dB or more. A shy person standing 50 cm from a microphone may generate only a few mV, while Arthur Leatherlungs shouting directly into the same microphone may produce nearly 1 V. Comparable differences exist between the sound levels produced by a flute, a trumpet, or a bass drum, and commonly used microphones differ in their voltage sensitivity by nearly two orders of magnitude. Inverse square law also contributes, especially when microphones are in close proximity to sources.

Second, those who speak and perform are often oblivious to the most carefully given instructions of the sound technician to “use microphone number one for flute and number three for trumpet.” A microphone may fail, or a stagehand may place it incorrectly, so on the spur of the moment, the performer must use a different microphone set up for a very different performance situation. The performance may be improvised on the spot, and the level at a microphone may overload the input stage without warning, or may be too close to the noise floor.

Third, the voltage sensitivity of commonly used microphones varies over nearly two orders of magnitude, increasing the range of signal levels that the input stage must be able to accept by about 30 dB.

All of these conditions are likely to require adjustment of the gain of the input stage, but if the performance is live, the adjustment must be transparent to the audience. This requires 1) that the gain of the preamplifier in a splitter be remotely controlled, or 2) that a very well-trained operator is standing by that

preamp while the show is in progress to make the required changes; and that the two or three operators mixing the performance make an equal and opposing change in gain in near perfect coordination with the change made at the stage! Condition #1 also requires that the total gain of the splitting system at any output does not change when the input trim is changed. That is, output gains must track input gains dynamically, and without audible clipping or other artifacts. The constraints of #1 pose a very complex design problem, and require a complex solution that few current products have successfully resolved. The constraints of #2 are so severe that few modern practitioners of live reinforcement choose to implement it in all but the best of conditions – a highly predictable program and top flight staffing at all levels.

Many are under the impression that the direct outputs of one mix desk can be used to feed other desks. This is often impractical for two reasons. First, direct outputs are rarely balanced, and often have pin 1 problems. Second, these outputs are nearly always taken off after the gain trim pot, so they will include changes made by the operator of that desk during the course of a production. The coordination of these changes is subject to the same challenges as those discussed with respect to active splitters.

TRANSFORMER FUNDAMENTALS

Audio transformers have two very useful properties. First, they can benefit circuit performance by transforming circuit impedances, to optimize amplifier noise performance for example. Second, because there is no direct electrical connection between its primary and secondary windings, a transformer provides electrical or galvanic isolation between two circuits.

A transformer consists of two or more coils of wire wound around a common core material that has suitable magnetic properties. Each coil is called a winding. The driven winding is called the primary, and all other windings are called secondaries. Transformers are passive devices, and can be used with any winding driven, thus which winding is the primary and which is a secondary will depend on how the transformer is connected.

To the extent that a transformer is lossless, the following conditions are true:

- 1) The ratio of the voltages in any two windings will be equal to the turns ratio between the two windings.
- 2) The ratio of the currents in any two windings will be inversely proportional to the turns ratio between the two windings.
- 3) The impedance “seen” by a device connected to any winding will be equal to the

parallel combination of the impedances connected to other windings multiplied by the square of the turns ratio to each of those windings.

The losses in real transformers, primarily due to wire resistance and core losses, will modify these conditions slightly, depending on their relationship to the impedances of connected circuitry.

Thus, a simple two-winding transformer having a 1:1 turns ratio, 25 ohms of wire resistance in each winding, and a 1,000 ohm resistor connected across its secondary will “look like” 1,050 ohms to a device driving its primary, and the voltage across the 1,000 ohm resistor would be a fractional dB lower than the input voltage. If the number of turns on the primary were doubled (a 2:1 turns ratio), the secondary voltage would be slightly less than half the primary voltage (due to losses), and the load would look like 4,150 ohms (including the wire resistance) to the driving source. Such a transformer would be said to be operating in stepdown mode.

Neglecting losses, a three-winding transformer having a turns ratio of 1:1:1 (that is, 1:1 from the primary to each secondary) and 1,000 ohms connected to each secondary would “look like” 500 ohms to a driving source connected to its primary. If the turns ratio were 2:1:1, the driving source would see 1,000 ohms, and each secondary would see one half of the source (primary) voltage.

Because transformer windings are in close physical proximity to each other, substantial capacitance can exist between them. This is undesirable because it defeats the desired isolation, especially at high-frequencies. However, this effect can be almost completely eliminated by the use of a Faraday shield between the windings. It generally takes the form of a thin sheet of copper foil placed between the windings. When connected to circuit ground, it intercepts the capacitive current that would otherwise flow between transformer windings. A Faraday shield should not be confused with a magnetic shield, which has a completely different purpose.

Transformers are used in microphone splitters for two fundamental reasons – first, to prevent the flow of shield current between desks, and second, to prevent negative interactions between the phantom power of on desk and the input circuit of another desk.

CURRENT PRACTICE

A passive microphone splitter solves the gain control problem by giving each mix operator control of his/her own input equipment. Three basic configurations (Fig 1, 2, and 3) are widely used.

Fig 1 illustrates a low cost method that is practical when d.c. isolation is not required between mix

desks, when technical grounding is sufficiently robust that shield current is not a problem, and when the mix desks can tolerate the other's phantom power. This configuration, commonly known as a "hard-wired" split, can be implemented by something as simple as a Y-cord that parallels the microphone to the two or three mix desks. The hard-wired split provides no isolation between the mix desks, so all desks "see" each other's phantom power and either (or all) can provide phantom power.

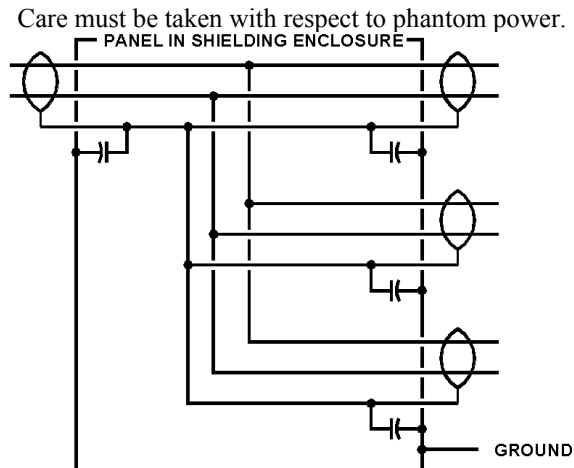

There is an unfortunate tendency on the part of desk manufacturers to skimp on the phantom power supply, giving it the capability to provide only half as much current (or even less) as specified by IEC 61938. Some supplies are poorly regulated, some switch off phantom power simply by removing power from the input of the power supply's regulator. There is also the possibility that the injection of phantom power from multiple desks might damage the microphone's power conversion circuitry, because the impedance through which the phantom power is injected is one-half the specified value (in the case of two desks) or even one-third (in the case of three).

Also, because there is a d.c. path between the shielded enclosures of the connected desks via the cable shields, there can (and almost always will) be current flowing on the shield due to the difference in potential between the grounded enclosures of desks that are connected to mains power at different locations. These currents, predominantly fundamental and harmonics of mains power, will be heard as hum and buzz if they enter the audio chain. This commonly happens two ways. First, nearly all mix desks manufactured before about 2000 (and many current products) have a design defect known as "the pin 1 problem" – improper termination of the cable shield (or the power supply's equipment ground) to the circuit board rather than the shielding enclosure.^{1 2} Second, shield current will be converted to a differential signal on the signal pair by a mechanism that Muncy called shield-current-induced noise (SCIN).³

The splitter of Fig 2 allows one mix desk, designated the "direct output," to have a d.c. connection to the microphone so that it can provide phantom power. The splitting transformer must have a number of windings equal to the number of mix desks. The transformer provides d.c. and common mode isolation between the mix desks, both between their signal wiring and isolation between their shielding enclosures from d.c. through audio frequencies (that is, it blocks shield current). The single most important function of the circuit of Fig 2 is to block audio frequency shield current, thus preventing the injection of hum and buzz by pin 1 problems and SCIN. These issues, as well as the function of the switches and the capacitors are addressed in greater detail in the section on EMC.

The splitter of Fig 3 provides full d.c. and common mode isolation between the microphone and all mix desks, as well as between mix desks, for the signal pair, and blocks shield current at audio frequencies. This configuration requires a transformer having one more winding than the number of split outputs, and it requires a phantom power supply at the splitter if condenser microphones will be used. In exchange for the added cost, it is the most robust of the passive configurations with respect to EMC, because the transformer isolates the microphone from RF that might be picked up on wiring connecting the mix desks to the splitter. A fuller discussion of this issue will be found in the section on EMC.

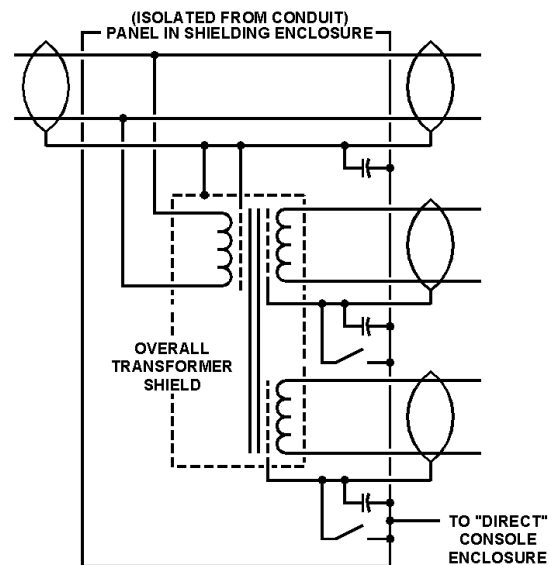

Fig 4 is the lumped parameter equivalent circuit of the direct coupled splitter of Fig 1. Typical microphones have actual output impedances of 150-300 ohms, and are specified to work into a load impedance of 750-1,000 ohms or higher. In this simple example, the three mix desks connected to the split each have input impedances of 1,500 ohms in parallel with 20 pF. To that impedance must be added the capaci-

tance between conductors of the cables between the microphone and the splitter, and between the splitter and the mix desks. Fifty meters of analog audio cable (typical for a performance setup) will exhibit a capacitance between conductors on the order 5 nF.

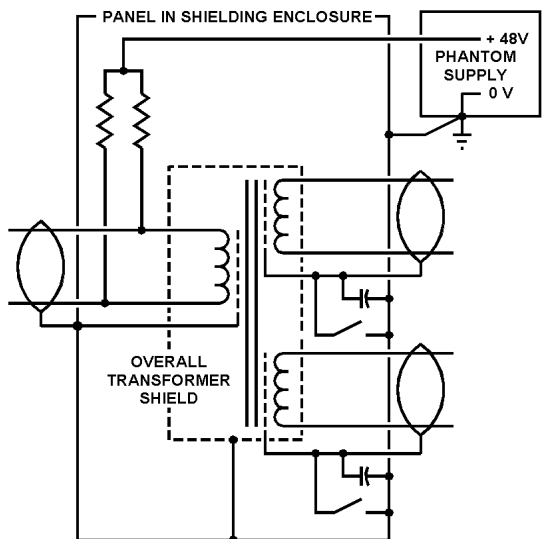

Figure 3 – Full transformer isolation

In this simple example, the microphone will see a resistive load of 500 ohms in parallel with a capacitance on the order of 18 nF (allowing for 20m of cable between mic and splitter). At 20 kHz, $X_C = 440 \Omega$, resulting in a Z_L of 330 ohms, which violates the rating of many microphones by a factor of 3. The primary effect of a capacitor microphone being overloaded in this manner is significantly increased distortion at levels well below the maximum rated SPL of the microphone. That is, at high signal levels, the output stage of the microphone is being asked to provide nearly 3 times the current it was designed to do. In addition to the increased distortion, the microphone sensitivity will be reduced by the voltage divider ratio between the microphone's source impedance and the abnormally low load impedance (typically 1-2 dB).

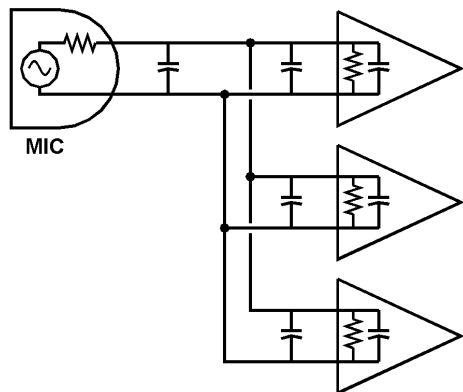

Figure 4 – Equivalent circuit of direct-coupled split
Fig 5 is the equivalent circuit that results from using the splitter of Fig 2. The additional resistors represent losses within the transformer, which are primar-

ily due to the resistance of the windings. 50 ohms is typical for each winding of a high quality microphone splitting transformer.

The introduction of the transformer causes a small (almost negligible) reduction of the overloading of the microphone by the three consoles (about 7% in our example). This occurs simply because the winding resistance increases (slightly) the load seen by the microphone from the two transformer-coupled mix desks.

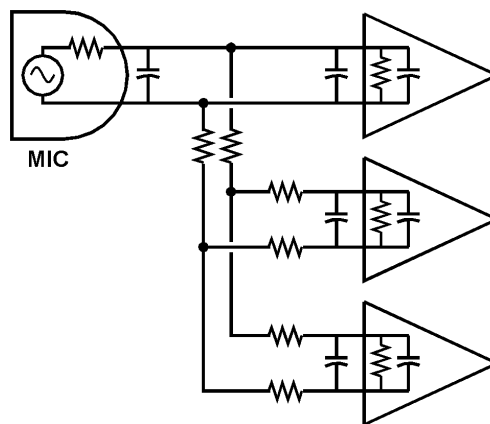

Figure 5 –Equivalent circuit for the splitter of Fig 2

The frequency response of dynamic microphones is affected by loading. Fig 6a is the equivalent circuit (ignoring diaphragm resonance) of a popular dynamic microphone, and Fig 6b is the magnitude of its output impedance, as measured and analyzed by Whitlock and Pettersen.⁴ Fig 6c is the simplified equivalent circuit as viewed from its output terminals. The 12 ohm capsule resistance, 157 μH capsule inductance, and 1.5 ohm primary resistance are multiplied by the square of the turns ratio and add to the secondary's leakage inductance and wire resistance. The result is 6 mH in series with 300 ohms. Fig 6d shows the microphone connected to the input of three mix desks through the typical runs of cables in our example (and many systems require much longer cables). The input capacitances are insignificant, and the equivalent circuit can be simplified as in Fig 6e.

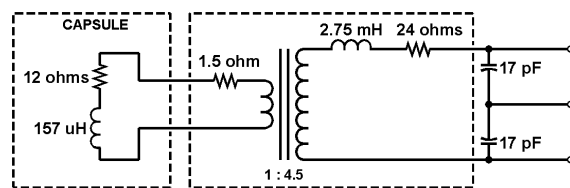

Figure 6a – Equivalent circuit of a typical dynamic microphone

From Fig 6e, we would expect to see a series resonance (at roughly 15 kHz) between the 6 mH inductance and the 18 nF cable capacitance that will be damped by the two resistances. If the cable capacitance were lower (if lower capacitance cable were to be used, or if the cables were shorter) the resonance would move higher in frequency. Cable types de-

signed to carry AES3 signals have much lower capacitance than older types, and are thus a superior choice for analog audio wiring. This is especially true when using splitters.

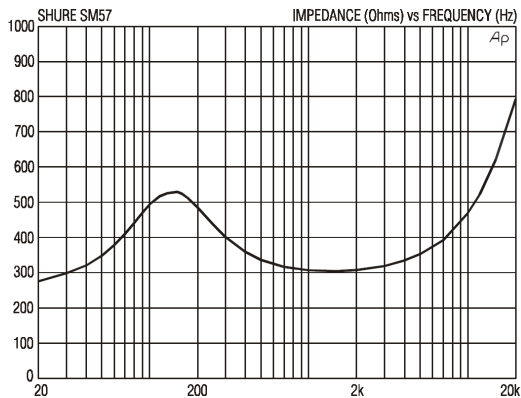

Figure 6b – Measured output impedance

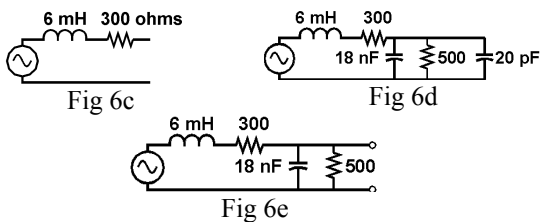

Fig 7a shows the effect of the loading of the microphone of Fig 6 by a single 1,500 ohm mix desk and three 1,500 ohm mix desks using ordinary microphone cable. Fig 7b shows the same computation if AES3 cable were to be used.

Fig 7c is the predicted variation of the low frequency response of the microphone of Fig 6 with resistive loading. Fig 7c was computed assuming that the microphone impedance is a pure resistance; this is both a conservative and reasonable assumption, because the impedance is resistive at the high and low limits of the impedance (at resonance and at mid-band), where it will give an accurate result. The error caused by ignoring the reactance simply causes the response dip at diaphragm resonance to appear broader than it really is.

While these variations in frequency response are small, they are not negligible. Indeed, octave-wide variations in amplitude response on the order of a dB are quite audible, and skilled balance engineers will likely use equalization to correct for the difference.

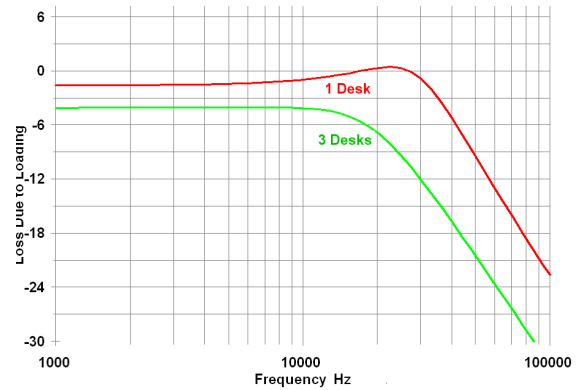

Fig 7a – Predicted change in the high frequency response of the microphone of Fig 6 feeding one or three 1,500 ohm desks with 6 nF of cable to each desk (57 m of typical analog cable, 105 pF/m)

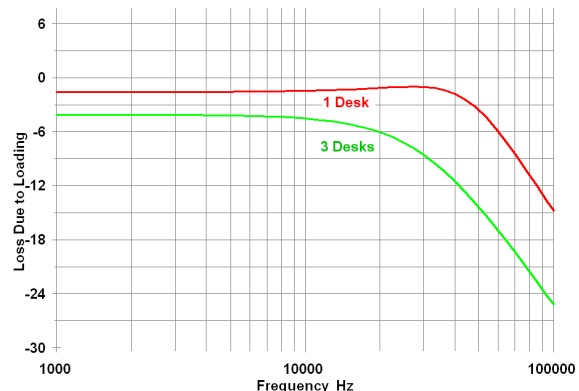

Fig 7b – The same conditions as for Fig 7a above, but using cable designed for AES3 (42 pF/m)

Fig 7d is the response of the microphone of Fig 6 to a capacitive load, measured using TDS (Time Delay Spectrometry) around 1989, using a loudspeaker as a source. For all of the data, the horizontal axis is frequency from 60 Hz to 31 kHz. Two measurements were made, one with the capacitance, and one without, and the results differenced to produce Fig 7d. The peak around 15 kHz is the resonance of the microphone's inductance with a capacitive load that corresponds to about 200m of cable, as predicted by Figs 7a and 7b, but at a lower frequency because the cable is longer. The data below 1 kHz is contaminated by room reflections, and should be ignored.

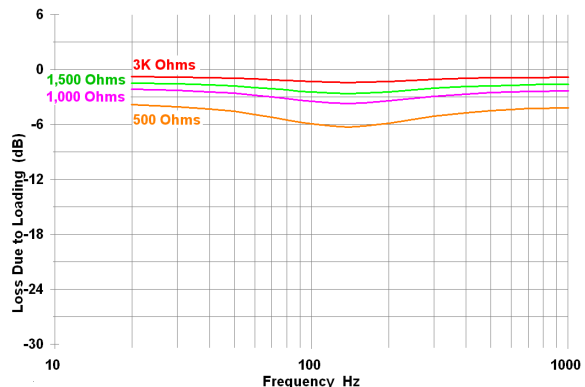

Fig 7c – Calculated effect on low frequency response

of the microphone as a function of resistive loading

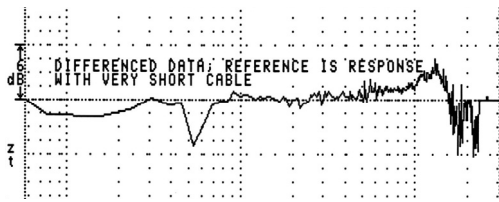

Fig 7d – Change in response when the microphone of Fig 6 is loaded by 22 nF paralleled by 10k ohms, as compared with 10k only. Limits of the horizontal axis are 60 Hz and 31 kHz. Data below 1 kHz is not valid.

CAPACITIVE LOADING OF LINE DRIVERS

The line drivers of capacitor microphones can be strongly affected by the capacitance of long cables. The line drivers of the microphones shown in Figs 8a and 8b have insufficient isolation from the load. Jensen showed that the response peak is the result of interaction between the load capacitance and the feedback network, and that adding resistance on the order of 60-100 ohms between the line driver and the load would minimize it.^{5 6 7} This defect is likely to cause a microphone to sound “spitty” in the presence of high frequency transients, thanks to its emphasis of those components, and to the lower threshold at which non-linear distortion occurs. Not all microphones suffer from this design defect, nor do they exhibit it to this degree.

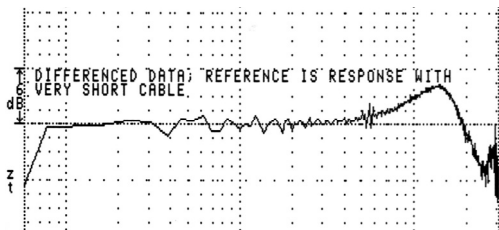

Fig 8a – Change in the response of a popular capacitor microphone caused by adding 22 nF in parallel with 10k ohms preamplifier input

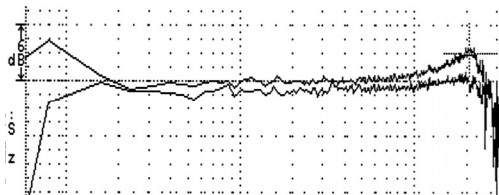

Fig 8b – Upper curve – change in response of another microphone loaded by 22 nF paralleled by 10k ohms, as compared to 10k ohms only; lower curve – change in response of microphone loaded by 22 nF paralleled by 910 ohms, as compared to 10k ohms only

Fig 9 is the equivalent circuit of a 2x1 splitter using the circuit of Fig 3. The new elements here are the pair of resistors (usually 6,800 ohms, closely matched to avoid degrading common mode rejection) used to inject phantom power. Since their series combination (13.6k ohms) is in parallel with the two mix desks, they further reduce the impedance. At low frequen-

cies, the mic would see 711 ohms driving two 1,500 ohm desks, and 482 ohms driving three of them.

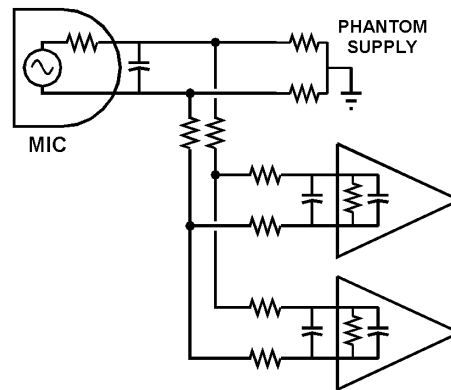

Figure 9 – Equivalent circuit for the splitter of Fig 3

STEPDOWN TRANSFORMERS

These loading problems can be solved by using a microphone splitting transformer with a stepdown turns ratio to one or more of the outputs. At least two design approaches are practical. Using the circuit of Fig 2, the microphone is direct coupled (that is, without the transformer) to one of the desks. This allows that desk to provide phantom power, and also provides the greatest output level to that desk, optimizing the signal to noise ratio to that desk. Additional mix desks are fed through the stepdown transformer, and receive less output from the microphone. This has the potential to reduce signal to noise ratio at desks fed through the stepdown transformer. In practice such degradation is unlikely -- circuit noise is rarely audible below the acoustic noise in musical applications where sound reinforcement is used.

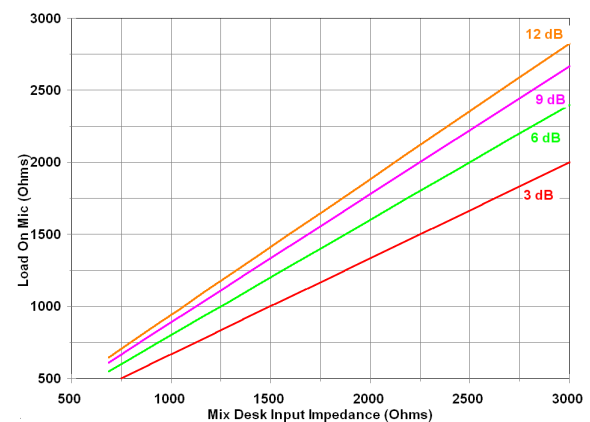

Figure 10 – Microphone loading versus stepdown voltage ratio and desk input impedance for a lossless 2-way stepdown splitter using the circuit of Fig 2

A major disadvantage of using this approach with the circuit of Fig 2 is that the highest impedance load that the microphone sees is limited by the input impedance of the directly-connected mix desk. Fig 10 shows the load presented to the microphone with one mix desk connected directly and one connected through a transformer having turns ratios of 1.4:1,

2:1, 2.8:1, and 4:1, resulting in a voltage stepdown of 3 dB, 6 dB, 9 dB, and 12 dB, respectively. Fig 11 shows these relationships for a 3-way split (that is, the direct desk plus two transformer-coupled desks). Figs 10 and 11 make it clear that a higher turns ratio allows mix desks of lower impedance to be used with minimum loading of the microphone.

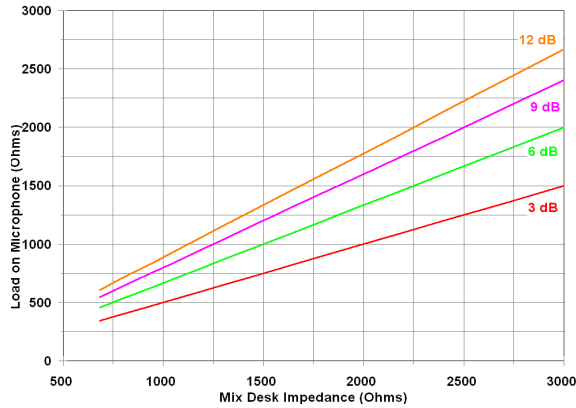

Figure 11 – Microphone loading versus stepdown voltage ratio and desk input impedance for a lossless 3-way stepdown splitter using the circuit of Fig 2

Figs 10 and 11 assume lossless transformers. While considering losses in the design would allow slightly lower impedance desks to be connected without degradation, it is also true that there will be some tolerance on the input impedance of the desks. Prudence thus suggests that losses ought to be ignored, allowing the slightly higher impedance to make up for a desk with an input impedance on the low side of its specified value.

Indeed, Fig 10 and 11 strongly suggest that the 4:1 turns ratio is the superior solution if microphone loading is the primary concern. But what about signal to noise ratio for the transformer-isolated desks? There’s more good news here – even though the signal is 12 dB lower, the source impedance is also much lower, giving the possibility of slightly lower circuit noise in the preamp and reduced susceptibility to some types of noise on interconnecting cables.

STEPDOWN WITH FULL ISOLATION

The most robust approach is to feed all of the mix desks through the split transformer and provide phantom power from the splitter, as shown in Fig 3. With this approach, a turns ratio to each output that divides each load impedance by the number of mixing desks connected to the splitter is practical. Thus, a two-output splitter would seem to require a three-winding transformer with a turns ratio to each secondary of 1.414:1, providing equal power division to the two desks (thus 3 dB below the microphone output). Using the same logic, a three output splitter would require 1.73:1 and each desk would see 4.8 dB less than the microphone’s output.

But those simple guidelines ignore the additional loading of the microphone by the phantom power supply that must be added at the splitter. Figs 12 and 13 show the resulting impedance relationships. The thin lines are the impedances of the mix desks reflected by the transformer, while the heavy lines include the loading of the phantom power resistors. Since some microphones are so intolerant of loading and some mix desks have relatively low input impedances, it would seem prudent to use turns ratios of at least 1.7:1:1 for a 2-way split and 2:1:1:1 for a 3-way split.

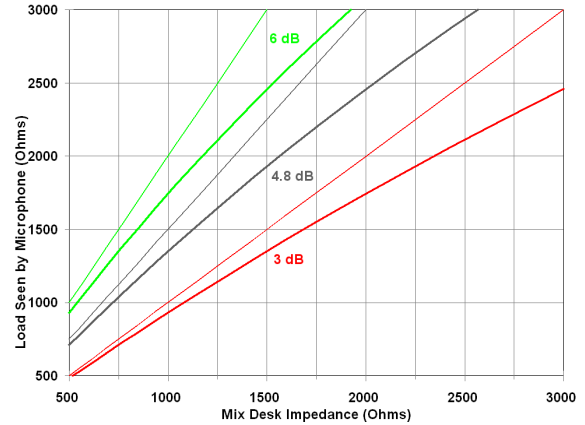

Figure 12 – Microphone loading versus stepdown voltage in dB and desk input impedance for a lossless 2-way stepdown splitter using the circuit of Fig 3

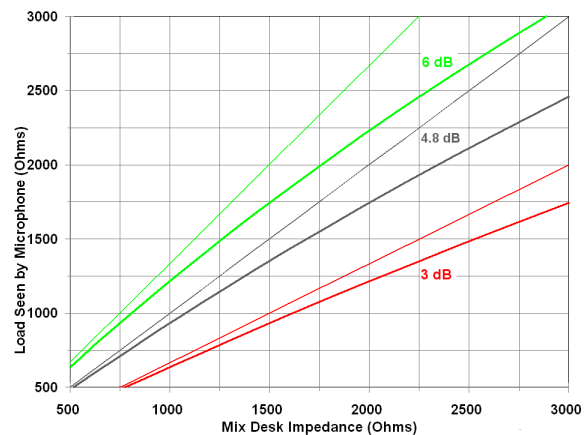

Figure 13 – Microphone loading versus stepdown voltage in dB and desk input impedance for a lossless 3-way stepdown splitter using the circuit of Fig 3

CAPACITANCE

Feeding all mix desks through the transformer and using equal turns ratios to all outputs has at least two other major advantages. Ignoring losses, any transformer operating in stepdown mode will divide the capacitive loading of the source by the square of the turns ratio. The longest cables connected to the splitter are usually those feeding the audience mix desk and the desk in a recording truck. Those feeding the stage monitor (foldback) mix are usually rather short. Capacitive loading of microphones by long cable

runs can be a serious problem in large facilities, so this impedance transformation is a major advantage of the stepdown approach.

Taking this logic a bit further, it is clear that a limitation of the circuit of Fig 2 with stepdown transformers is that the transformers will not divide the capacitance of the cable to the desk that provides phantom power (that is, the one that is direct coupled), and that is usually either the recording desk or the reinforcement desk.

The magnitude of the cable capacitance problem should not be underestimated. Over the past 20 years, the facilities where sound reinforcement systems are used have gotten increasingly larger, necessitating the use of very long cables to interconnect microphones and mix desks. The 18 nF load cited in these examples is typical of a facility on the order of 1,000 seats using older style cable designed for analog audio. In larger facilities, the cables might easily be 2-3 times longer. The use of cables designed for AES3 signals could bring the capacitance in these larger facilities back down to the 20 nF range.

It should also be noted that cables of so-called “quad” construction have capacitance between conductors that is approximately double that of a conventional twisted pair. While these cables can provide superior rejection of magnetic fields, the price paid is an approximate doubling of all capacitances over that of conventional analog cables, and a capacitance per unit length that is approximately six times that of cable designed for AES3.

FREQUENCY RESPONSE – DYNAMIC MICS

Fig 14a is the predicted high frequency response when the microphone of Fig 6 feeds a 1/3 split using 1:1 and 2:1 stepdown transformers. Fig 14b is for the same conditions, but with lower capacitance AES3 cable feeding all three desks.

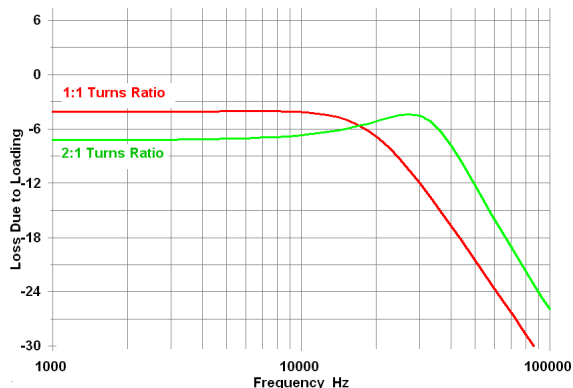

Fig 14a – Loss due to loading when the mic of Fig 6 feeds three 1,500 ohm mix desks using 1:1 and 2:1 transformers as in Fig 13

A variation of the circuits of Fig 1, 2 and 3 that dates back at least 30 years adds equal low value resistors

(typically 33 ohms) in series with each conductor of the microphone and each conductor of each output. This has several effects. First, loading is reduced slightly. Second, the effects of a short circuit at any one output will be limited to a partial loss of signal and increased distortion at high signal levels at other outputs. Third, the isolation of capacitor microphones from a high capacitance load will be improved, since the series resistors serve to increase the build-out resistance. All of these effects are generally beneficial. On the negative side, some signal will be lost across the resistance, there will be increased high frequency rolloff of dynamic microphones, and common mode rejection will be degraded if the resistors are not very precisely matched. It is also important that resistors having low excess noise (for example, wirewound and bulk metal film types) be used where d.c. will be present.

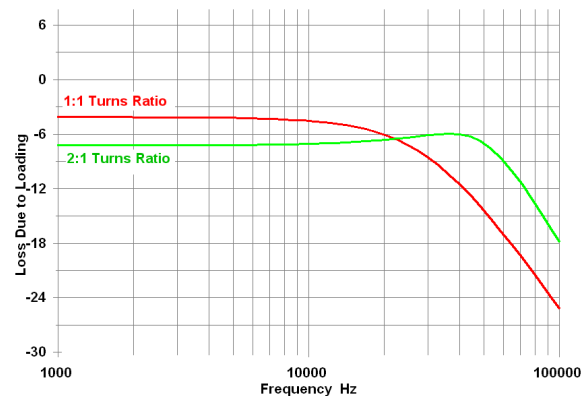

Fig 14b – Loss due to loading for the same conditions as Fig 13, but using AES3 cable to feed the desks

EMC CONSIDERATIONS

From an EMC perspective, it is also quite beneficial to isolate all mix desks with the transformer using the circuit of Fig 3 (that is, with a phantom supply fed at the splitter, and no direct coupled outputs). First, in this configuration, microphone shields are grounded at the splitter, so the length of the cable that can act as a receiving antenna to couple RF onto cable shields is greatly reduced. This significantly reduces susceptibility to MF and HF interference (that is, AM broadcast and shortwave transmitters). It also reduces susceptibility to interference like lighting buzz.

Second, if the split transformer has a Faraday shield associated with each winding, the Faraday shield can be the connecting point for the shield of the cable feeding the respective desks. The Faraday shield of the primary winding should be connected to the primary cable shield and to the Equipment Ground. If the transformers are well made, this configuration can provide excellent isolation to prevent common-mode coupling of RF across the transformer.

As already noted, an important function of a microphone splitting transformer is to block audio fre-

quency shield current on the wiring that interconnects the microphones and the mix desks by interrupting the path for that current. Shield current is problematic because it excites both pin 1 problems and SCIN. Both of these mechanisms have been shown to be major contributors to hum, buzz, and RF interference in audio systems.^{8,9}

By its nature, a transformer functions as a band-pass filter. Microphone splitting transformers typically exhibit a two-pole or three pole low-pass response with a -3dB frequency on the order of 250 kHz, thus attenuating any differential-mode RF that SCIN may induce onto the signal pair (Fig 15). This filtering action, combined with the RF grounding of the cable shields at the splitter (by the capacitors), serves to break the microphone-to-mix desk cable into two parts (that is, on either side of the splitter). This has the effect of shortening the cables that might serve as receiving antennas for RF interference, making the fully transformer-isolated splitter (Fig 3) more robust with respect to EMI. The filter will also be in place between the wiring feeding the connected mix desks for the partially isolated circuit of Fig 2 (but not between the microphone and the direct-connected desk).

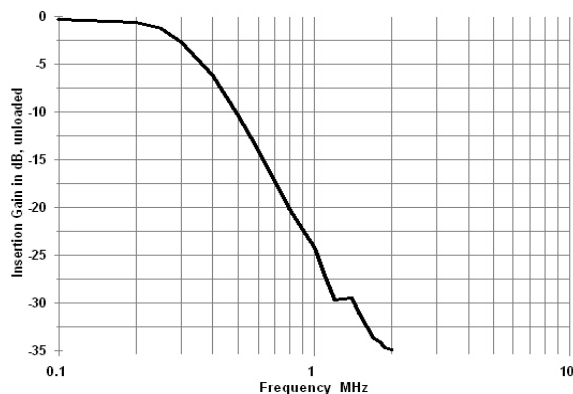

Fig 15 – Measured low-pass response of a high-quality microphone splitting transformer

All of the splitter drawings show capacitors between the cable shield and the shielding enclosure of the splitter. The function of these capacitors is to maximize the shielding of the cables at frequencies where their electrical length is greater than $\lambda/10$ at the frequency of an interfering signal. For these capacitors to be effective, they must have very low parasitic inductance and resistance. This requires leads of “zero length” and places limits upon their internal construction. Adequate termination of the cable shield for signals of longer wavelengths (that is, lower frequencies) will be provided by the connection of the shield at the mix desks.

The switches shown in Figs 2 and 3 are often added in the hope that some magically chosen combination of their settings might somehow eliminate “ground buzz.” When the switches are closed, they allow

shield current to flow between the mix desks, thus exciting both SCIN and pin 1 problems. It is the opinion of the authors that these switches should be omitted, with the cost of the switch (materials, labor, and panel space) spent instead on high quality transformers that have a Faraday shield for each winding. The additional isolation provided by the better transformers is likely to solve far more problems than the switches.

All of the splitters are shown within shielding enclosures. A metallic but non-ferrous shield will provide only electric field shielding. If the shielding enclosure is steel, it will also provide some degree of magnetic shielding. Additional immunity to magnetic fields can be achieved by tightly twisting each signal pair within the splitter, and by using mumetal shields on the transformers.

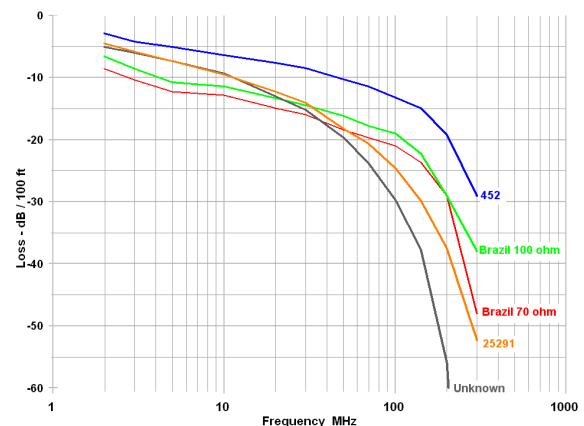

Figure 16a – Loss of typical analog foil/drain-shielded cables

Much has been made of the need to prevent small interruptions in the shielding of portable microphone cables at VHF and UHF. In the opinion of the authors, this concern is wildly overblown. Fig 16a shows loss data for foil/drain-shielded balanced cables typically used for permanent installation of audio systems. Fig 16b shows comparable data for braid-shielded cables commonly used as portable microphone cables. These data were measured using an Agilent E5091A network analyzer and laboratory quality baluns having good performance to 300 MHz. Data points, taken visually from screen dumps of the data, were transferred to a spreadsheet. Figs 16a and 16b are plotted from that spreadsheet. The upper three curves on Fig 16b are cables specified for use with digital audio per AES3. All other cables are designed for analog audio.

The significance of Figs 16a and 16b with respect to this issue is that audio cable is quite lossy at the very high frequencies where small interruptions in shielding could allow significant RF to enter the cable. Consider a portable microphone cable plugged into a passive splitter or two microphone cables connected together on stage, connected by at least 6 m of this

cable to a microphone preamplifier.

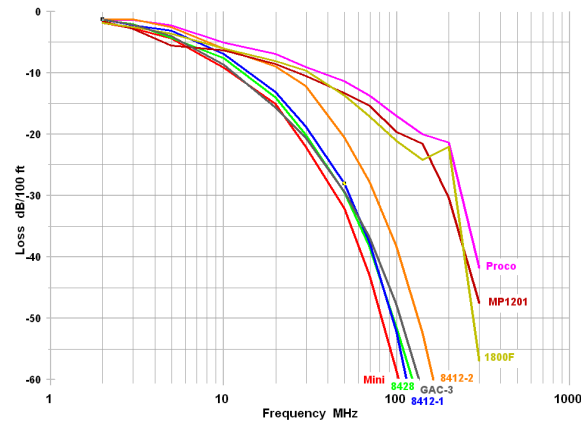

Figure 16b – Loss of typical braid-shielded cables

The cable shield is typically interrupted at a junction of XL-type connectors for a distance of up to 7 cm so that it can be carried through pin 1. Seven cm is $\lambda/20$ at 210 MHz. A study of Ott¹⁰ suggests that a single aperture no larger than 7 cm should have a shielding effectiveness on the order of 25 dB at this frequency, and the pair inside the cable is balanced and twisted, which should further reduce any coupling. Once the RF is inside the cable, it would encounter loss of at least 4 dB in that 6m cable for the least lossy of these cables, and >12 dB for many of them. And that is for a rather short 6m cable connecting the splitter to an on-stage mix desk; losses would be two orders of magnitude greater in the typical 50-75m run to the audience mix desk or 75-100 m run to a recording truck.

Susceptibility due to this break in shielding does not get worse with increasing frequency – although shielding effectiveness decreases with increasing frequency, the data show that cable loss is increasing even more quickly.

This is not to say that a very strong interfering field would present no measurable signal at the input of active equipment, but it will almost certainly be at an amplitude low enough that equipment having a reasonable degree of immunity ought to reject it.

FARADAY SHIELDS AND ISOLATION

Figs 17a and 17b show splitters built with transformers having no Faraday shield, or only one Faraday shield. With both of these splitters, cable shields must be directly connected together at the splitter – they must be connected at the splitter, and there is simply no other place to connect them. With respect to shield current, this configuration is no better than the direct-coupled splitter, because it provides a path for audio frequency shield current. Indeed, its only advantage over the hard-wired split (Fig 1) is that it eliminates the possibility of interference between the phantom power supply of one desk and the input stage of another desk, a result that could be achieved

at far lower cost by adding capacitors in series with the non-direct outputs of the splitter of Fig 1.

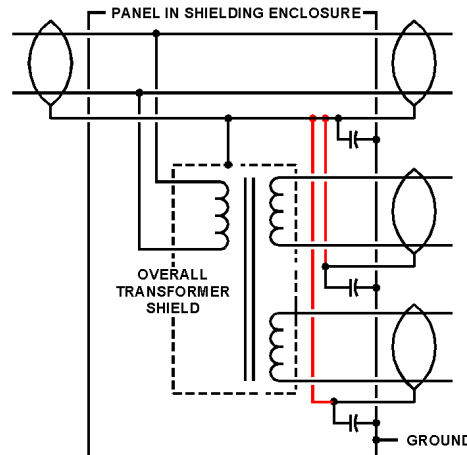

Fig 17a – Split transformer with no Faraday shield

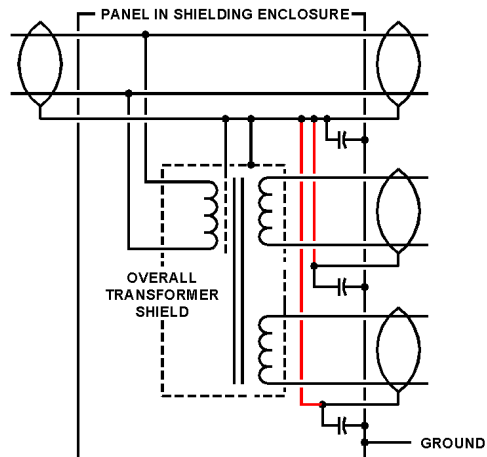

Fig 17b – Split transformer with one Faraday shield

The common mode isolation of both of these splitters is also compromised as compared to the splitters of Figs 2 and 3. The splitter of Fig 17a has no Faraday shield, so capacitive coupling between the windings rises rapidly with frequency. The common mode isolation of the splitter of Fig 17b is a bit better, but is limited by the impedance of the connection between the Faraday shield and ground.

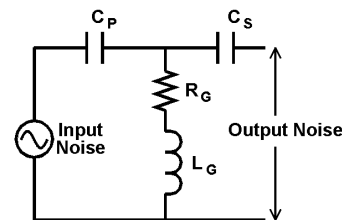

Fig 18 – High frequency common-mode equivalent circuit of two-winding transformer having a single Faraday shield

Fig 18 illustrates the second problem. Fig 18 is the simplified common-mode high frequency equivalent circuit of a two-winding transformer having a single Faraday shield. The junction of C_p and C_s is the

Faraday shield, R_G and L_G are the parasitic impedance of the connection of the Faraday shield to ground, and C_P and C_S are the capacitances between the Faraday shield, the primary, and the secondary. In essence, R_G and L_G become a common impedance between the primary and the secondary, an impedance that will increase with frequency thanks to the inductive reactance. At low frequencies, that impedance is low, and the Faraday shield shorts common-mode noise to ground. As frequency increases, more noise will be coupled to the output rather than shorted to ground. At some high frequency, the parasitic inductance will resonate with the capacitive coupling to the secondary, making the Faraday shield ineffective as that frequency is approached and exceeded.

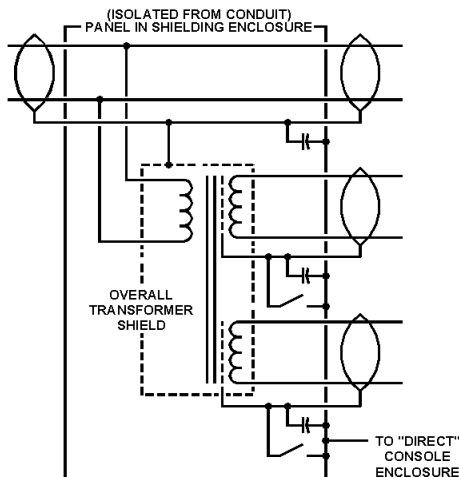

Fig 19 – Split transformer with Faraday shields on each secondary but none on the primary

The splitter of Fig 19 has one Faraday shield for each secondary, with each Faraday shield connected to its associated cable shield. The cable shield for the primary is connected to the splitter enclosure and overall transformer enclosure, and runs unbroken to the direct-connected desk that provides phantom power. This configuration provides common mode isolation and low-pass filtering of the signal pair between the mix desks, and blocks shield current between the desks. Common mode isolation between the microphone wiring and the isolated desks is not as good as the configuration of Fig 2, because common mode conversion can occur on the primary winding due to capacitive imbalances between the primary winding and the secondary shields, but it is superior to the configurations of Figs 17a and 17b because it blocks audio frequency shield current.

DISCUSSION

It is clear that microphones, mix desks, microphone splitters, and microphone cabling all should be designed to minimize the negative interactions among them. The effect of loading on dynamic microphones is limited to a reduction in level and modifications to their frequency response. While these effects are a

nuisance and should be avoided, they can be corrected by equalization at the mix desk because there is no amplitude non-linearity.

The effect of loading on capacitor microphones is far less benign because excessive loading will result in amplitude non-linearity at high signal levels, in addition to modification of the frequency response. Looking for the cause of excessive distortion in some miniature lectern mics in typical church reinforcement systems, Rayburn identified the cause as insufficient current capability of the output stage. Reporting on his work, he noted that “one popular lectern microphone loses 15 dB of headroom as the resistive load goes from 1,000 ohms to 700 ohms.”¹¹ Rayburn also notes that the inline attenuators sold by the same company that makes the problematic microphone loads the microphone with 150 ohms! On his advice, that product has been revised to reduce the microphone loading, but the problematic attenuators have been on the market for nearly 30 years!

Loading can easily be reduced with little, if any, negative effect on performance by three simple measures, the benefits of which are additive.

- Increase the input impedance of mix desks to the highest practical value. The authors see no practical reason why an input impedance of 3k ohms cannot be achieved simply by deciding to do it, and no good reason why it should not be done.
- Use only cables having the lowest practical capacitance for all microphone wiring. While low capacitance cable costs a bit more than higher capacitance cable (because it is manufactured in smaller quantities and to higher precision), the cost of the cable itself is a small fraction of the cost of interconnecting wiring. The major contributors to that cost are the connectors and wiring panels used to terminate the cable, the labor to pull the cable, and the labor to terminate the cable at the connectors.
- Use stepdown mode transformers for all passive microphone splitting.

Noise produced at the output of a microphone pre-amplifier will be the summation of three mechanisms. They are: 1) thermal (Johnson) noise proportional to the resistive component of circuit impedance; 2) the internal noise of the circuit components, primarily the active devices; 3) noise induced on the interconnecting wiring by external fields.¹² #1 (thermal noise) will be proportional to the resistive component of the parallel combination of the microphone's output impedance, the desk's input impedance, and any other desks connected through a splitter. In most situations, this impedance is dominated by the microphone's output impedance (and, at high

frequencies, the cable capacitance). If a stepdown splitter is used, the microphone source impedance will be divided by the square of the turns ratio. #2 is typically small in a well-designed preamplifier, but the current noise component related to the input will increase with increasing values of that same parallel combination of circuit impedances. #3 (noise coupled into interconnecting cables) is a function of circuit impedance, the balance of those impedances, and the ability of the input stage to reject common-mode noise. Again, these impedances are dominated by the source impedance and, at high frequencies, the cable capacitance.

An argument that has been advanced against raising the input impedance of mix desks is the relatively high level of circuit noise (#1, #2) and noise coupled by microphone cables (#3) with no microphone connected. These noise components will be reduced in level when a microphone is plugged in, and will be overwhelmed by acoustic noise picked up by that microphone. But when an input is turned up with no microphone connected, the desk may be perceived as noisy by an uneducated consumer. Except as noted below, we see no easy solution to this other than education of the consumer.

It is clear that the magnitude of a desk's input impedance is an insignificant contributor to circuit noise for all conditions when a functioning microphone is connected. Occasionally a small mixer will be used in a simple system set up to operate with no human operator. Sometimes that mixer will have "automatic mixing" circuitry that senses which microphones someone is speaking into, making those active, and muting all others. In other systems, there is no automatic circuitry, and some or all inputs are active all the time at gain settings that have been adjusted to be suitable with the selected microphones and conditions of use. In these manually operated systems, circuit noise and cable noise may be audible with no microphone connected, and can be reduced to an acceptable level if the input impedance is lower. If the mixer has a high input impedance, an acceptable low-noise condition is readily achieved by the addition of a fixed resistor in parallel with the input.

One technique that has been used to address this issue is to pass the microphone line through a switched patching jack that places a termination resistor across the line with no microphone connected. While there is nothing wrong with the concept of switched loading, the use of jack-fields for microphone wiring is itself highly problematic. The presence of phantom power can combine with even the slightest degradation or intermittence of the contacts to produce a "crackling" noise signal. In microphone circuits, even very low levels of such noise can be problematic.

Capacitor microphones can and should be made more

robust with respect to loading. Thanks to advances in low noise microphone preamplifier design, the ability of the microphone to reproduce high sound pressure levels without distortion and low sound pressure levels without circuit noise is far more important than having a high voltage sensitivity.

Better microphone designs have long resolved these conflicting requirements by including some form of switched attenuation between the capsule and the output stage so that an operator may optimize performance at either high or low sound pressure levels. As the dynamic range of microphone electronics has improved, the switches have been eliminated from some products, both to improve reliability (the switches can be problematic in the long term) and reduce cost. If, however, they solve the loading problem by reducing output current requirements at high sound pressure levels, they should be used.

In our view, the preference for one microphone over another for sound reinforcement will be strongly related to how that microphone performs when loaded by two or three mix desks connected by long cables and subjected to high sound pressure levels. There is no question that a microphone that performs well under heavy loading at high sound pressure levels will win in this arms race. In other words, good performance under heavy loading is directly related to the success of a microphone in the sound reinforcement market.

CONCLUSIONS

1. High quality mix desks and microphones both tend to have long useful lives, so microphones, mix desks, and all elements of the microphone to mix desk interface should be designed with legacy equipment in mind.
2. Input equipment, especially mix desks, should be designed with the highest practical input impedance consistent with good performance. A resistance $> 3,000$ ohms in parallel with <50 pF should be a design goal.
3. Microphones should be designed to tolerate the lowest practical load impedance consistent with good performance. All microphones should be able to drive 750 ohms in parallel with 25 nF without audible distortion at rated sound levels, and 500 ohms in parallel with 30 nF should be a design goal.
4. Switched attenuation within capacitor microphones can allow the operator to minimize the distortion caused by the combination of high sound pressure levels and excessive loading. The omission of such a switch is poor economy if the microphone cannot perform well both under these condi-

tions and at low sound levels without it.

5. Cable capacitance will cause a high frequency peak in the response of many capacitor microphones. This effect can be minimized by providing sufficient resistive isolation between the line driver and the line.
6. The response of dynamic microphones will be modified by low values of load impedance. This can be avoided only by minimizing both capacitive and resistive loading.
7. Low capacitance cable, such as that designed for the transport of AES3 signals, should be used for all analog audio, and the use of older style, high capacitance cable (>50 pF/m) should be phased out.
8. To provide isolation between cable shields, each winding of a microphone splitter transformer should have its own Faraday shield, and each Faraday shield should be connected to the shield of the cable connected to the associated winding. Such a configuration will also minimize the coupling of RF through the transformer.
9. A splitting transformer that lacks a Faraday shield, or one that has fewer Faraday shields than the number of secondaries, is little better than a direct-coupled split.
10. The most robust passive microphone splitting system is one in which all outputs are isolated by a high quality transformer. This configuration will also prevent loading problems if it has a stepdown turns ratio of 2:1.
11. A splitter with one direct output and one or more transformer-isolated outputs should use a split transformer having a turns ratio to each secondary of 4:1.
12. Ground-lift switches on microphone splitters are of little value. The cost of these switches (material, panel space, and labor) would be far better spent on a better quality transformer that has a Faraday shield for each winding.
13. Commonly used passive attenuators load microphones quite severely. They will likely cause a capacitor microphone to become highly distorted at even moderate signal levels, and will significantly modify the response of dynamic microphones.

ACKNOWLEDGMENTS

The authors would like to acknowledge the contributions of members of the AES Standards Committee Working Group on Microphones and the Working

Group on EMC to a series of very useful discussion of the issues raised by a preliminary version of this paper. Ray Rayburn, David Josephson, Rick Chinn, Yuri Shulman, Bruce Olson, Bob Schulein, and John Eargle provided especially useful input. Gordon Carter pointed author Brown to the Jensen papers 16 years ago. Steve Kusiceil provided the test equipment and assisted with the cable loss measurements.

REFERENCES

- ¹ N. Muncy, "Noise Susceptibility in Analog and Digital Signal Processing Systems," *J. Audio Eng. Soc.*, vol 43, No. 6, pp 435-453, 1995, June
- ² AES48 *AES standard on interconnections – Grounding and EMC practices – Shields of connectors in audio equipment containing active circuitry*, Audio Engineering Society 2005
- ³ *ibid*
- ⁴ B. Whitlock and M. Pettersen, ed. Ballou, *Handbook for Sound Engineers, Third Edition*, Chapter 21, pp 600-602, Focal Press, Boston, 2002
- ⁵ D. Jensen, *Some Tips on Stabilizing Operational Amplifiers*, Recording Engineer/Producer, Vol 9, No 3; pp 42-53; June 1978
- ⁶ D. Jensen, *Long Line Application*, Jensen Transformers Applications Note, Jensen Transformers, 1987
- ⁷ J. Brown, *The Effect Of Cable On Signal Quality*, Sound and Video Contractor, Sept 20, 1990, pp 22-33.
- ⁸ J. Brown, *Testing for Radio Frequency Common Impedance Coupling (the "Pin 1 Problem") in Microphones and Other Audio Equipment*, AES Preprint 5747, New York, October 2003
- ⁹ J. Brown, and B Whitlock, *Common-Mode to Differential-Mode Conversion in Shielded Twisted-Pair Cables (Shield Current Induced Noise)*, AES Preprint 5747, Amsterdam, March 2003.
- ¹⁰ H. Ott, *Noise Reduction Techniques in Electronic Systems*, Second Edition, Wiley, New York, 1988.
- ¹¹ J. Brown, *Mic Splitters*, SynAudCon Newsletter, vol 32, nr 4, December 2004
- ¹² B. Whitlock and M. Pettersen, *op.cit.* pp 603-604